

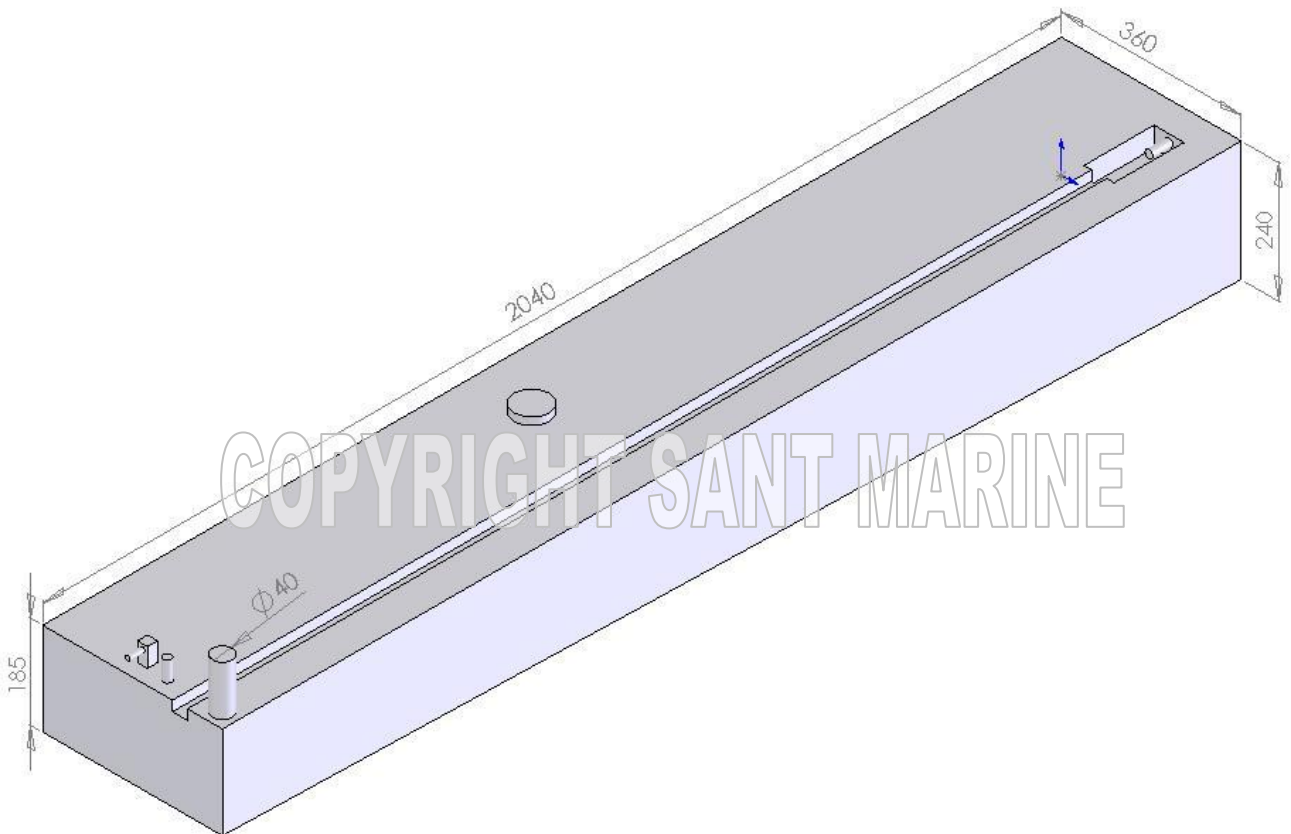

Model:	11-597
Capacity:*	125 Litres
CE/NMMA Approval:	N
Revision Date:	19-Jan-07



Important Information:

1. Polyethylene fuel tanks are subject to expansion of 3% within a month after being filled with fuel.
2. The dimensions shown above represent the size of the tank **after** such expansion. The size of the cavity should not be less than the dimensions shown.

* The capacity stated above is the internal volume of the tank. The fuel carrying capacity may vary depending on the positioning of the tank within the boat, the angle of the boat in the water and the location of breathers and fittings.